

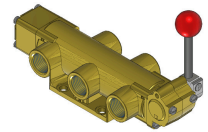

22 Spring Valley Rd.
Paramus, NJ 07652
(201) 843-2400
sales@versa-valves.com

Valve, 4-Way, Brass

TUH-4504

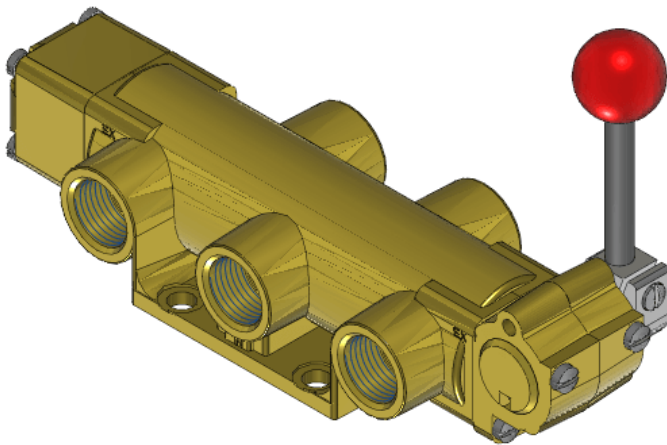

Description

T Series Directional Control Valve

The VERSA 1/2" brass T Series Valves are suited for many low-pressure hydraulic directional control applications. The T Series provides trouble-

free performance under the most demanding conditions. The integrity of design makes them adaptable to a maximum number of applications with a minimum of components. The modular approach to valve construction allows valve bodies and actuating devices to be interchanged end for end and valve for valve, allowing for thousands of possible valve variations and enabling the customer to "build" the valve to fit the project's unique specifications.

Product Features

- Constructed of forged brass for long-lasting, corrosion-resistant strength. Functions without fail when exposed to mud, water, salt, grime, oils and chemicals

100% Leak Tested • 10-Year Warranty

Specifications

Actuation	Hand Lever-Offset \ Detent 3-positions
Function	4-way, 3-pos, Cylinder ports open to exhaust
Port Size	Body Ported, 1/2" NPT
Valve Pressure Range (PSI)	0-500 psi
Valve Pressure Range (BAR)	0-34.5 bar
Primary Flow	4.0 Cv
Media	Hydraulic
Temperature Range (F)	5°F to 131°F
Temperature Range (C)	-15°C to 55°C
Body & Internal Parts	Brass
Weight	5.040000

This spec sheet is intended for informational purposes only and while VERSA strives for accuracy, same does not constitute a warranty or guarantee, express or implied, regarding any products or services described herein. VERSA reserves the right to amend its product designs, details, specifications, and other information at any time without prior notice. VERSA also publishes information on its website at [VERSA-Valves.com](https://www.versa-valves.com) and information can be sought by contacting customer service at 201-843-2400 option 3, or emailing to sales@versa-valves.com.