

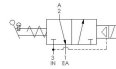

22 Spring Valley Rd.
Paramus, NJ 07652
(201) 843-2400
sales@versa-valves.com

Valve, 3-Way, SST, 24VDC

VAG-3321-316-181D-XXN4-D024

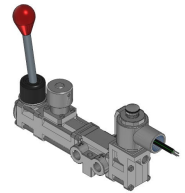
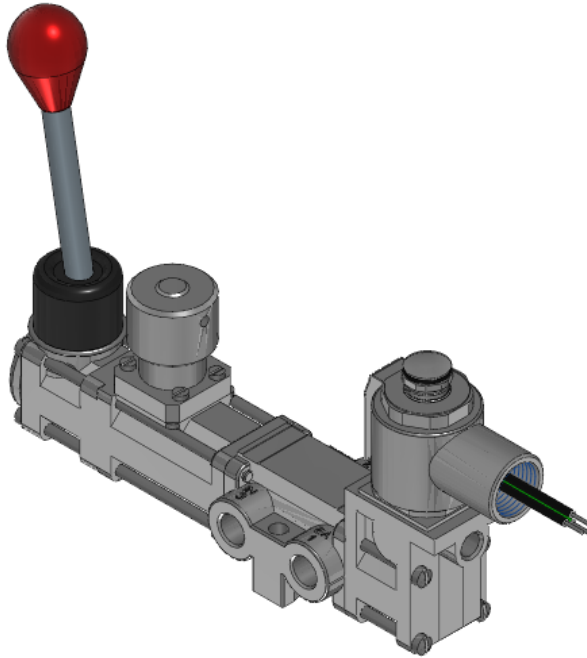

Specifications

Actuation	Solenoid-Pilot \ Hand Lever-Centerline 1-Position Latch on Return With Spring Return
Function	3-way, 2-pos, NC
Port Size	Body Ported, 1/4" NPT
Valve Pressure Range (PSI)	55-120 psi
Valve Pressure Range (BAR)	3.79-8.27 bar
Primary Flow	1.8 Cv
Media	Air - Inert Gas, Natural Gas
Gas Temperature Range (F)	-4°F to 194°F
Gas Temperature Range (C)	-20°C to 90°C
Dust Temperature Range (F)	-4°F to 194°F
Dust Temperature Range (C)	-20°C to 90°C
Body & Internal Parts	316L Stainless Steel
Weight	4.810000

Solenoid Specifications

Solenoid Description	Hazloc- E5 Class
Voltage	24 V DC \pm 10% (D024)
Power	1.8 W
Inrush Current (mA)	77
Holding Current (mA)	77
Resistance Ω	312
Ingress Protection Rating	NEMA 4X
Electrical Protection	Not applicable
Area Classification	Cl I, Grps C,D - Cl II, Grps E,F,G - Cl I, Div 2, Grps A,B,C,D - Cl II, Div 2, Grps E,F,G
Coil Class	Std
T Rating (Gas)	4
T Rating (Dust)	4
Solenoid Housing Material	Steel - Plated
Solenoid Seal Material	FKM
Solenoid Connection	1/2" NPT female conduit with 24" wires
Certification	cULus

This spec sheet is intended for informational purposes only and while VERSA strives for accuracy, same does not constitute a warranty or guarantee, express or implied, regarding any products or services described herein. VERSA reserves the right to amend its product designs, details, specifications, and other information at any time without prior notice. VERSA also publishes information on its website at [VERSA-Valves.com](https://www.versa-valves.com) and information can be sought by contacting customer service at 201-843-2400 option 3, or emailing to sales@versa-valves.com.