

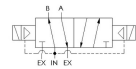

22 Spring Valley Rd.
Paramus, NJ 07652
(201) 843-2400
sales@versa-valves.com

Valve, 4-Way, Brass, 120V60Hz

VGG-4522-LB-XN-A120

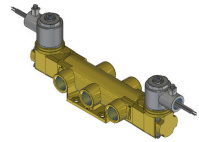
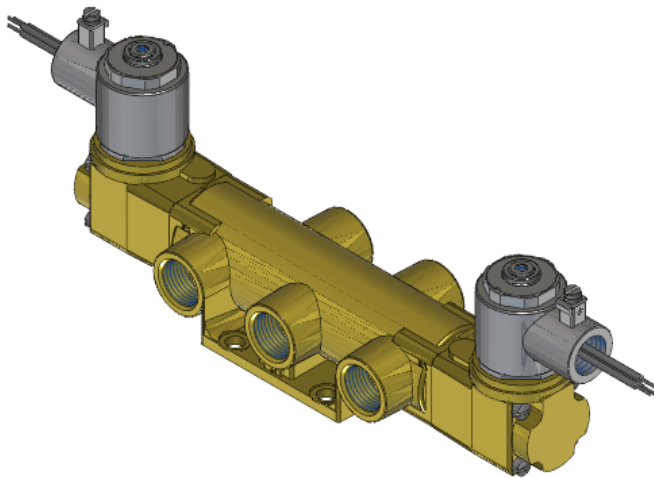

Description

Versa V Series Directional Control Valve

The VERSA 1/2" brass V Series valves are suited for nearly all pneumatic directional control applications. The V Series is designed for trouble-

free performance even in the harshest environments. The integrity of design makes them adaptable to a maximum number of applications with a minimum number of components. This is possible through the modular approach to valve construction, which allows valve bodies and actuating devices to be interchanged end for end and valve for a valve in many cases. The modular approach to this valve design makes thousands of valve variations possible, allowing the customer to "build" his valve to fit his unique specifications.

Product Features

- Constructed of forged brass for long-lasting, corrosion-resistant strength. Functions without fail when exposed to mud, water, salt, grime, oils and chemicals
- Buna-N/nitrile rubber o-ring seals perform reliably with oil, fuel, and other chemicals over broad temperature range

Solenoid Features

- Solenoid coil connection: M20 female conduit with 24" wires

100% Leak Tested • 10-Year Warranty

Specifications

Actuation	Double Solenoid-Pilot
Function	4-way, 2-pos
Port Size	Body Ported, 1/2" NPT
Valve Pressure Range (PSI)	20-120 psi
Valve Pressure Range (BAR)	1.38-8.27 bar
Primary Flow	4.0 Cv
Media	Air - Inert Gas, Natural Gas
Temperature Range (F)	-4°F to 131°F
Temperature Range (C)	-20°C to 55°C
Body & Internal Parts	Brass
Weight	7.200000

Solenoid Specifications

Solenoid Description	Hazloc - E5 Class XN Option
Voltage	120 V 60 Hz ±10% (A120)
Power	3.6 VA
Inrush Current (mA)	60
Holding Current (mA)	30
Resistance Ω	1085
Ingress Protection Rating	IP65
Electrical Protection	Not applicable
Area Classification	II 2 G Ex d IIB + H2 T3...T6 Gb
Coil Class	Std
Protection Classification	d
Zone	1
T Rating (Gas)	6
Solenoid Housing Material	Steel - Plated
Solenoid Seal Material	FKM
Solenoid Connection	M20 female conduit with 24" wires
Certification	ATEX, IECEx, INMETRO, TR-CU

This spec sheet is intended for informational purposes only and while VERSA strives for accuracy, same does not constitute a warranty or guarantee, express or implied, regarding any products or services described herein. VERSA reserves the right to amend its product designs, details, specifications, and other information at any time without prior notice. VERSA also publishes information on its website at [VERSA-Valves.com](https://www.versa-valves.com) and information can be sought by contacting customer service at 201-843-2400 option 3, or emailing to sales@versa-valves.com.