

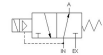

22 Spring Valley Rd.
Paramus, NJ 07652
(201) 843-2400
sales@versa-valves.com

Valve, 3-Way, Brass, 48VDC

VGS-3422-D048

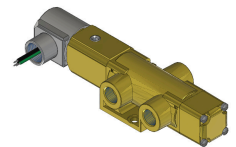
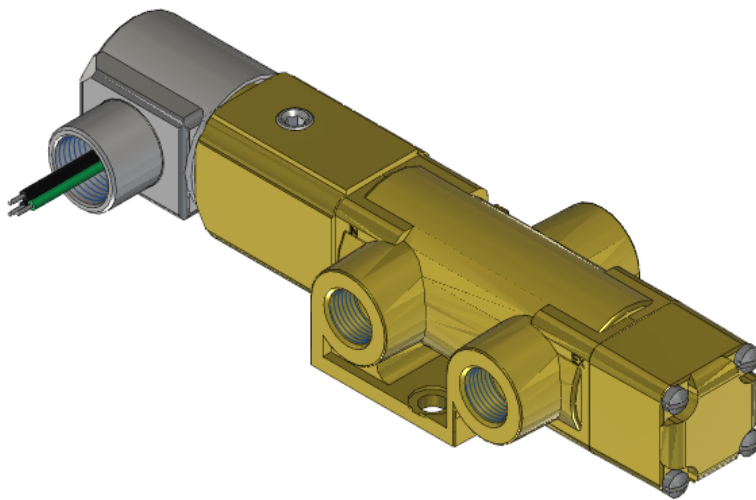

Description

Versa V Series Directional Control Valve

The VERSA 1/2" brass V Series valves are suited for nearly all pneumatic directional control applications. The V Series is designed for trouble-

free performance even in the harshest environments. The integrity of design makes them adaptable to a maximum number of applications with a minimum number of components. This is possible through the modular approach to valve construction, which allows valve bodies and actuating devices to be interchanged end for end and valve for a valve in many cases. The modular approach to this valve design makes thousands of valve variations possible, allowing the customer to "build" his valve to fit his unique specifications.

Product Features

- Constructed of forged brass for long-lasting, corrosion-resistant strength. Functions without fail when exposed to mud, water, salt, grime, oils and chemicals
- Buna-N/nitrile rubber o-ring seals perform reliably with oil, fuel, and other chemicals over broad temperature range

Solenoid Features

- Solenoid coil connection: 1/2" NPT female conduit with 24" wires

100% Leak Tested • 10-Year Warranty

Specifications

Actuation	Solenoid-Pilot Spring Return
Function	3-way, 2-pos, NO
Port Size	Body Ported, 3/8" NPT
Valve Pressure Range (PSI)	40-175 psi
Valve Pressure Range (BAR)	2.76-12.1 bar
Primary Flow	3.4 Cv
Media	Air - Inert Gas, Natural Gas
Temperature Range (F)	-10°F to 104°F
Temperature Range (C)	-23°C to 40°C
Body & Internal Parts	Brass
Weight	4.570000

Solenoid Specifications

Solenoid Description	GP - E Class
Voltage	48 V DC ±10% (D048)
Power	9.5 W
Inrush Current (mA)	193
Holding Current (mA)	193
Resistance Ω	249
Ingress Protection Rating	NEMA 1,2,3
Electrical Protection	Not applicable
Area Classification	General purpose
Coil Class	Std
Solenoid Housing Material	Steel - Plated
Solenoid Seal Material	Buna
Solenoid Connection	1/2" NPT female conduit with 24" wires
Certification	CSA, UL

This spec sheet is intended for informational purposes only and while VERSA strives for accuracy, same does not constitute a warranty or guarantee, express or implied, regarding any products or services described herein. VERSA reserves the right to amend its product designs, details, specifications, and other information at any time without prior notice. VERSA also publishes information on its website at [VERSA-Valves.com](https://www.versa-valves.com) and information can be sought by contacting customer service at 201-843-2400 option 3, or emailing to sales@versa-valves.com.