

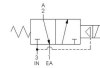

22 Spring Valley Rd.
Paramus, NJ 07652
(201) 843-2400
sales@versa-valves.com

Valve, 3-Way, SST, 125VDC

VSG-3321-316-XX-D125

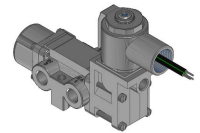
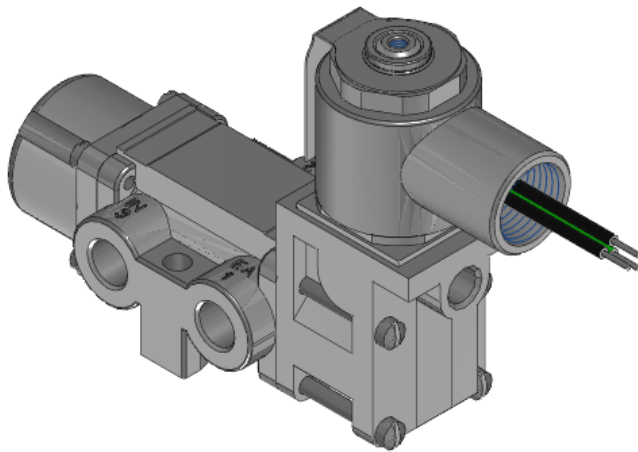

Description

V-316 Series Directional Control Valve

The 1/4" V-316 Series directional control valve is suited for the most demanding applications. Ruggedly constructed, internally and externally, of

stainless steel, these valves can withstand the physical abuse of corrosive environments and controlled media. The modular design concept utilizes three basic sub-assemblies: a body assembly and two actuator assemblies that simplify circuit planning while affording almost unlimited combinations.

Product Features

- Constructed of SAE 316L marine grade stainless steel conforming to NACE standard MR-01-75 suitable for direct exposure to sour environments
- FKM o-ring seals perform reliably with exposure to hydrocarbons or highly corrosive fluids over a broad temperature range: equivalent to Viton®, Fluorel®

Solenoid Features

- Solenoid coil connection: 1/2" NPT female conduit with 24" wires

100% Leak Tested • 10-Year Warranty

Specifications

Actuation	Solenoid-Pilot Spring Return
Function	3-way, 2-pos, NC
Port Size	Body Ported, 1/4" NPT
Valve Pressure Range (PSI)	40-175 psi
Valve Pressure Range (BAR)	2.76-12.1 bar
Primary Flow	1.8 Cv
Media	Air - Inert Gas, Natural Gas
Gas Temperature Range (F)	-4°F to 104°F
Gas Temperature Range (C)	-20°C to 40°C
Dust Temperature Range (F)	-4°F to 104°F
Dust Temperature Range (C)	-20°C to 40°C
Body & Internal Parts	316L Stainless Steel
Weight	2.710000

Solenoid Specifications

Solenoid Description	Hazloc- E5 Class
Voltage	125 V DC ±10% (D125)
Power	7.2 W
Inrush Current (mA)	62
Holding Current (mA)	62
Resistance Ω	2030
Ingress Protection Rating	NEMA 1,2,3
Electrical Protection	Not applicable
Area Classification	Cl I, Grps C,D - Cl II, Grps E,F,G - Cl I, Div 2, Grps A,B,C,D - Cl II, Div 2, Grps E,F,G
Coil Class	Std
T Rating (Gas)	3C
T Rating (Dust)	3C
Solenoid Housing Material	Steel - Plated
Solenoid Seal Material	FKM
Solenoid Connection	1/2" NPT female conduit with 24" wires
Certification	cULus

This spec sheet is intended for informational purposes only and while VERSA strives for accuracy, same does not constitute a warranty or guarantee, express or implied, regarding any products or services described herein. VERSA reserves the right to amend its product designs, details, specifications, and other information at any time without prior notice. VERSA also publishes information on its website at [VERSA-Valves.com](https://www.versa-valves.com) and information can be sought by contacting customer service at 201-843-2400 option 3, or emailing to sales@versa-valves.com.