

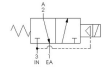

22 Spring Valley Rd.
Paramus, NJ 07652
(201) 843-2400
sales@versa-valves.com

Valve, 3-Way, SST, 24VDC

VSG-3421-316-XDBT9-D024

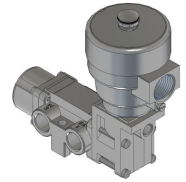
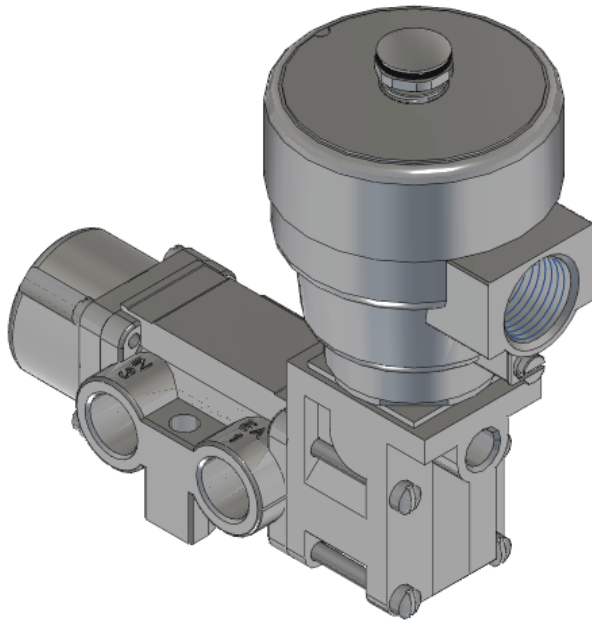

Description

V-316 Series Directional Control Valve

The 1/4" V-316 Series directional control valve is suited for the most demanding applications. Ruggedly constructed, internally and externally, of

stainless steel, these valves can withstand the physical abuse of corrosive environments and controlled media. The modular design concept utilizes three basic sub-assemblies: a body assembly and two actuator assemblies that simplify circuit planning while affording almost unlimited combinations.

Product Features

- Constructed of SAE 316L marine grade stainless steel conforming to NACE standard MR-01-75 suitable for direct exposure to sour environments
- FKM o-ring seals perform reliably with exposure to hydrocarbons or highly corrosive fluids over a broad temperature range: equivalent to Viton®, Fluorel®

Solenoid Features

- Solenoid coil connection: 1/2" NPT female conduit with integral junction box

100% Leak Tested • 10-Year Warranty

Specifications

Actuation	Solenoid-Pilot Spring Return
Function	3-way, 2-pos, NC
Port Size	Body Ported, 3/8" NPT
Valve Pressure Range (PSI)	40-175 psi
Valve Pressure Range (BAR)	2.76-12.1 bar
Primary Flow	2.0 Cv
Media	Air - Inert Gas, Natural Gas
Temperature Range (F)	-4°F to 194°F
Temperature Range (C)	-20°C to 90°C
Body & Internal Parts	316L Stainless Steel
Weight	3.630000

Solenoid Specifications

Solenoid Description	Hazloc - E4 Class XDB Option
Voltage	24 V DC \pm 10% (D024)
Power	1.8 W
Inrush Current (mA)	75
Holding Current (mA)	75
Resistance Ω	320
Ingress Protection Rating	IP66 / 67 / 68, NEMA 4X & 6P
Electrical Protection	Not applicable
Area Classification	Cl I, Grps B,C,D - Cl I, Div 2, Grps A-D, Cl II, Grps E,F,G - Cl III, Cl I, Zn 1 A/Ex db IIC - Cl II, Zn 21 AEx tD A21, DIP A21
Coil Class	H
Protection Classification	db tb
Zone	1
T Rating (Gas)	4
T Rating (Dust)	135
Solenoid Housing Material	Stainless Steel - Type 316L
Solenoid Seal Material	FKM
Solenoid Connection	1/2" NPT female conduit (integral junction box)
Certification	ATEX, cCSAus, IECEx, INMETRO, KC, NEPSI-CCC, PESO, TR-CU, TS OSHA

This spec sheet is intended for informational purposes only and while VERSA strives for accuracy, same does not constitute a warranty or guarantee, express or implied, regarding any products or services described herein. VERSA reserves the right to amend its product designs, details, specifications, and other information at any time without prior notice. VERSA also publishes information on its website at [VERSA-Valves.com](https://www.versa-valves.com) and information can be sought by contacting customer service at 201-843-2400 option 3, or emailing to sales@versa-valves.com.