

## SERIES K TYPE VALVES

# WERSA<sup>®</sup>

BULLETIN  
K-2002

### AIR VALVES FOR INDUSTRY SINCE 1949

## Series K Valves—

a compact  
air management  
system

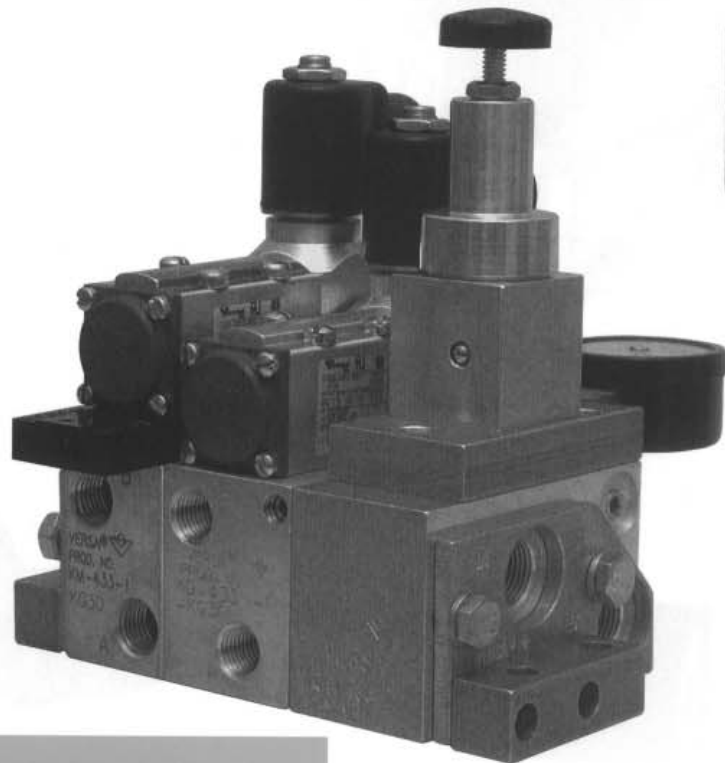

- 2-, 3-, 4-, and 5-Way
- 2- and 3-position
- Solenoid/Pilot, Pilot, Manual or Cam Actuation
- 4.7 mm ( $C_v = 0.7$ ) or 6.5 mm ( $C_v = 1.2$ ) Orifice
- Stacking Manifolds & Single Station Subplates

**WERSA<sup>®</sup>**  
www.versa-valves.com *Valves*

Series K — A Versa® valve system that combines compact design and stacking modular manifolds, with clean good looks, and easy maintenance.

## INTERCHANGEABILITY

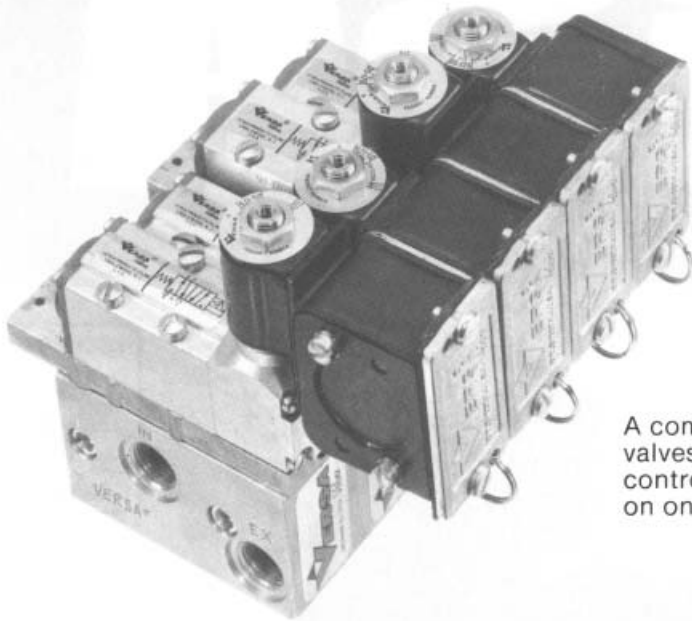

K 6.5 and K 4.7 valves mount interchangeably on the Series K stacking modular manifold

Both valves require the same space, have the same mounting hole size and location, and utilize the same junction boxes.

**Valves mount compactly on 1¼ centers, except on 1½" centers when hazardous service solenoids or regulators are required.**

Solenoid/pilot, pilot, cam and manually operated valves mount on same manifold assembly.

A combination of K 6.5 valves and K 4.7 valves, with and without cylinder speed control plates, with junction boxes ... all on one manifold assembly.



Valves can be equipped with Nonhazardous Service—standard (NEMA 1,2,3), DIN-standard (NEMA 4), DIN-low watt (NEMA 4), Hazardous Service—standard or Hazardous Service-low watt (NEMA 7 & 9) type solenoids.

Epoxy-molded class A or class F coil. Class H coil optional.

Coils available for most AC or DC voltages. (See page 14)

**Easy maintenance: just three screws hold valve to manifold.**

All connections—air and electrical—stay put when valve is removed.

FKM (fluorocarbon) "O" rings standard.

The use of an air line filter and lubricator is recommended for prolonged life of all system components. See page 13.

Guarded Manual Override is standard on all solenoid operated valves. Other manual override options for solenoid operated and pilot operated valves are available (see page 8).

Wiring is easy with unique stacking NEMA 12 junction box that has terminal strip on cover.

The valve can be removed leaving the junction box in place.

Other wiring options are: MS type quick disconnect, conduit housing, grommet housing, and DIN style coil (see page 8).

Stacking screws eliminate tie rods. Threaded inlet and exhaust ports eliminate endplates.

Stacking Manifold valve stations may be easily added or subtracted.

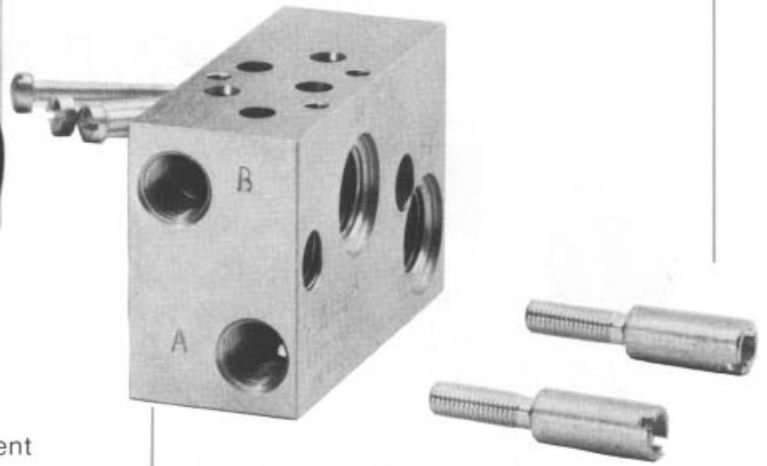
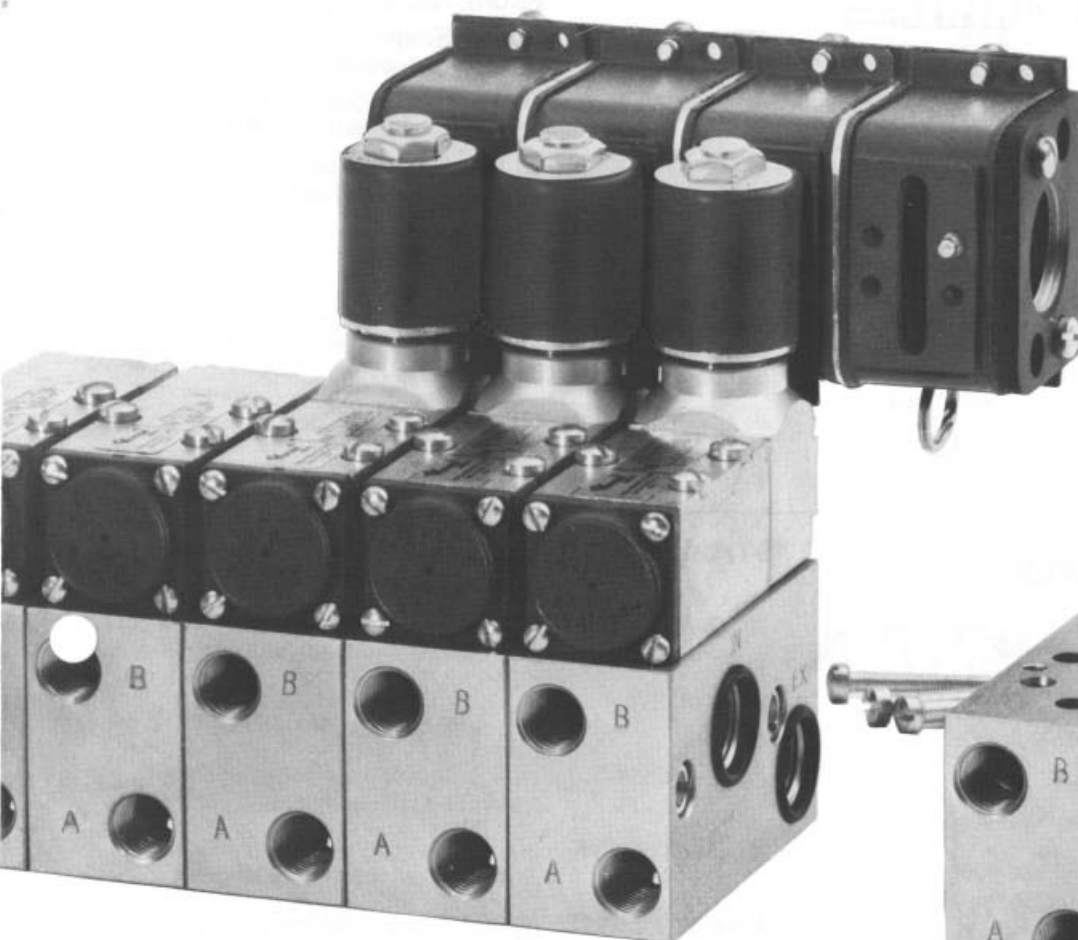

Side and bottom 1/4" NPT cylinder ports for convenient installation.

Common inlet and exhaust ports are 3/8" NPT.

**Manifold assembly with required valves is tested and shipped assembled.**

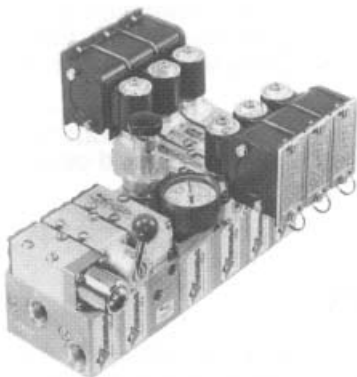

Lever and cam operated valves, a single pilot valve, a regulator module, and three double solenoid valves all mount together in one manifold assembly.

# Series K

2 and 3-Way valve functions are accomplished by using a 4-way valve on the appropriate Stacking Manifold in which the appropriate port(s) has been plugged, or on a single station 4-Way Subplate.

5-Way valves are only available in K6.5 size. Any K6.5 valve listed can be supplied as a 5-Way. To specify change first digit of the product number to "5." Example: KSG-4332 becomes KSG-5332.

## SINGLE SOLENOID 4-WAY VALVES

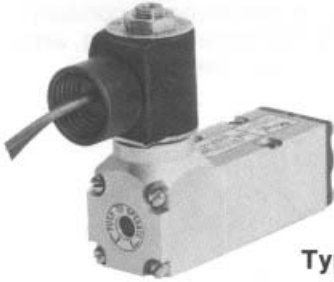

Typical Single Solenoid Shown.

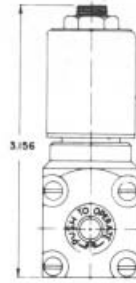
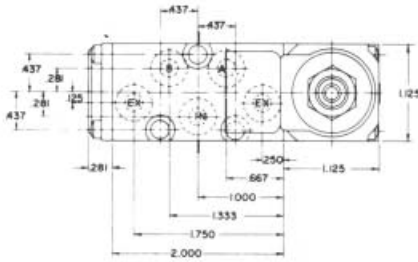

### \*STANDARD (NONHAZARDOUS SERVICE)

- KSG-4232:** (K 4.7) Single Solenoid — spring return, two-position, INPilot
- KSG-4332:** (K 6.5) Single Solenoid — spring return, two-position, INPilot
- KSG-4212-K30:** (K 4.7) Single Solenoid — spring return, two-position, EXPilot
- KSG-4312-K30:** (K 6.5) Single Solenoid — spring return, two-position, EXPilot

\*Low watt solenoid operators, solenoid operators for hazardous locations, and DIN type solenoid operators are also available. See pages 8 & 9.

## DOUBLE SOLENOID 4-WAY VALVES

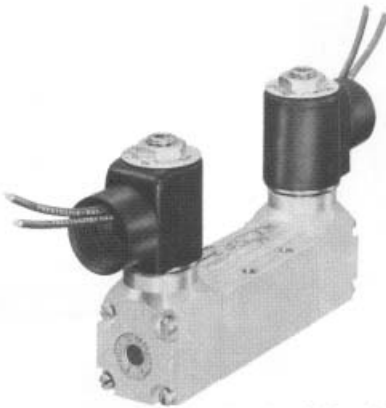

Typical Double Solenoid Shown.

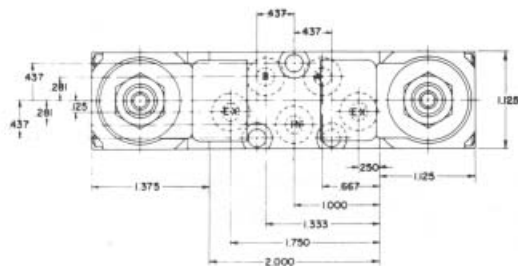
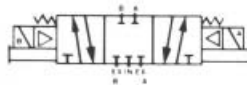

### \*STANDARD (NONHAZARDOUS SERVICE)

- KGG-4232:** (K 4.7) Double Solenoid—two-position, two-detent, INPilot
- KGG-4332:** (K 6.5) Double Solenoid—two-position, two-detent, INPilot
- KGG-4232-K30:** (K 4.7) Double Solenoid—two-position, two-detent, EXPilot
- KGG-4332-K30:** (K 6.5) Double Solenoid—two-position, two-detent, EXPilot
- KXX-4333:** (K 6.5) Double Solenoid—spring centering, three-position, INPilot, all ports blocked in center
- KXX-4333-K30:** (K 6.5) Double Solenoid—spring centering, three-position, EXPilot, all ports blocked in center
- KXX-4334:** (K 6.5) Double Solenoid—spring centering, three-position, INPilot, cylinder ports exhausting in center
- KXX-4334-K30:** (K 6.5) Double Solenoid—spring centering, three-position, EXPilot, cylinder ports exhausting in center

\*Low watt solenoid operators, solenoid operators for hazardous locations, and DIN type solenoid operators are also available. See pages 8 & 9.

### COILS/VOLTAGES

See page 14 for complete range of coils available. Specify coil code as addendum to valve product number.

## SINGLE PILOT 4-WAY VALVES



Typical Single Pilot Shown.

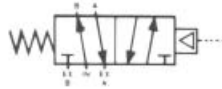

**KSP-4212-K30:** (K 4.7) Single Pilot—  
spring return, two-position

**KSP-4312-K30:** (K 6.5) Single Pilot—  
spring return, two-position

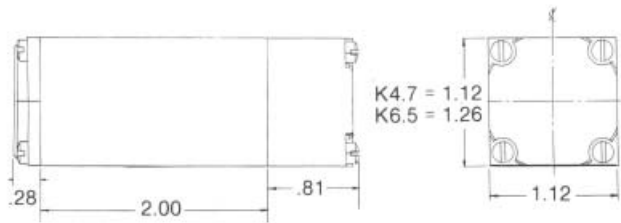

## DOUBLE PILOT 4-WAY VALVES



Typical Double Pilot Shown.

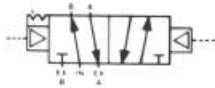

**KPP-4232-K30:** (K 4.7) Double Pilot—  
two-position, two-detent

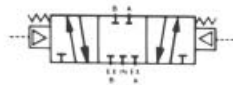

**KPP-4332-K30:** (K 6.5) Double Pilot—  
two-position, two-detent



**KJJ-4333-K30:** (K 6.5) Double Pilot—  
spring centering, three-position, all  
ports blocked in center

**KJJ-4334-K30:** (K 6.5) Double Pilot—  
spring centering, three-position,  
cylinder ports exhausting in center



# Series K

2 and 3-Way valve functions are accomplished by using a 4-way valve on the appropriate Stacking Manifold in which the appropriate port(s) has been plugged, or on a single station 4-way Subplate.

5-Way valves are only available in K6.5 size. Any K6.5 valve listed can be supplied as a 5-Way. To specify change first digit of the product number to "5." Example: KSG-4332 becomes KSG-5332.

## LEVER-OPERATED 4-WAY VALVES



KSL-4312 Shown.

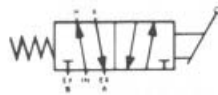

**KSL-4212:** (K 4.7) Lever-Operated—spring return, two-position

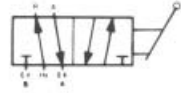

**KSL-4312:** (K 6.5) Lever-Operated—spring return, two-position

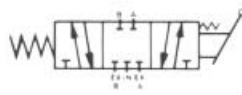

**KNL-4212:** (K 4.7) Lever-Operated—two-position, without spring return



**KNL-4312:** (K 6.5) Lever-Operated—two-position, without spring return



**KBL-4313:** (K 6.5) Lever-Operated—spring centering, three-position, all ports blocked in center

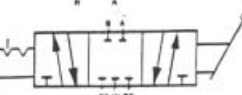

**KBL-4314:** (K 6.5) Lever-Operated—spring centering, three-position, cylinder ports exhausting in center

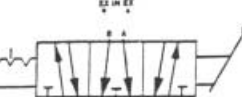

**KZL-4212:** (K 4.7) Lever-Operated—two-position, detented

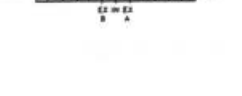

**KUL-4213:** (K 4.7) Lever-Operated—three-position, detented, all ports blocked in center



**KUL-4214:** (K 4.7) Lever-Operated—three-position, detented, cylinder ports exhausting in center

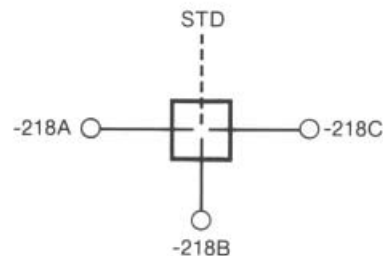
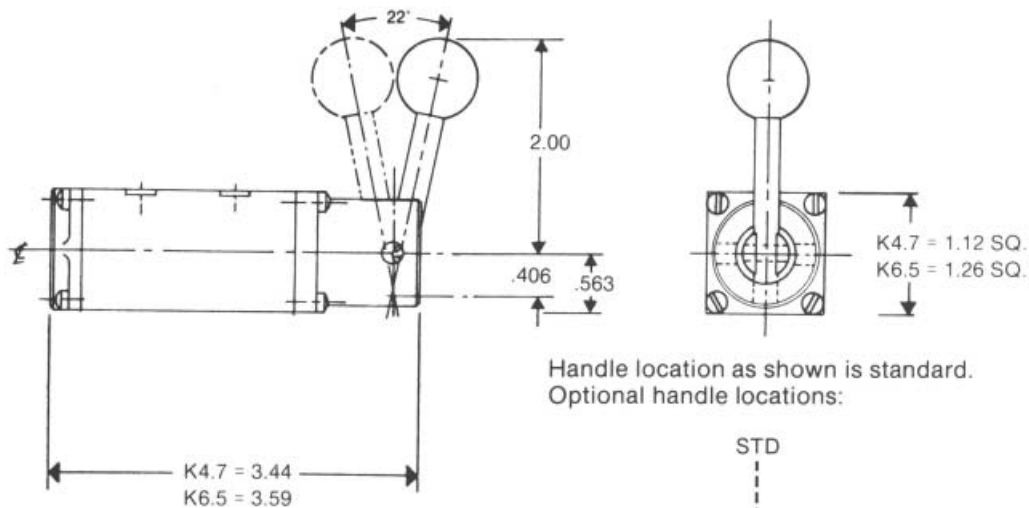

## KNOB-OPERATED 4-WAY VALVES

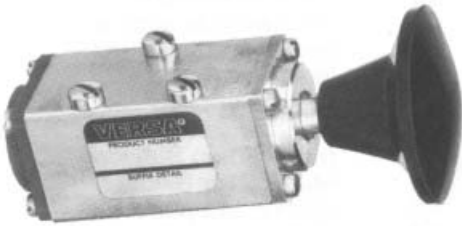

**KSI-4212 Shown.**

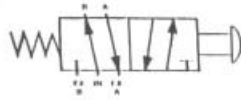
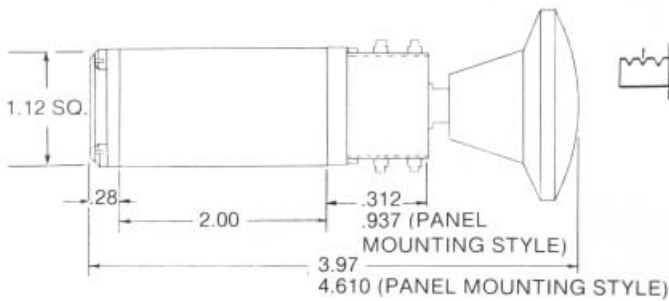

**KSI-4212:** (K 4.7) Knob-Operated—spring return, two-position. For panel mounting style specify KSI-4212-P.



**KNI-4212:** (K 4.7) Knob-Operated—two-position, no spring return. For panel mounting style specify KSI-4212-P.

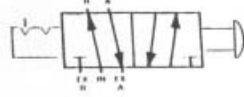

**KZI-4212-P:** (K 4.7) Knob-Operated—two-position, detented, panel mounting style.

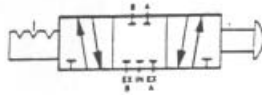

**KUI-4213-P:** (K 4.7) Knob-Operated—three-position, detented, all ports blocked in center, panel mounting style.

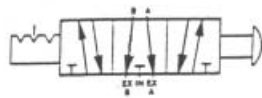

**KUI-4214-P:** (K 4.7) Knob-Operated—three-position, detented, cylinder ports exhausting in center, panel mounting style.

Knob-operated valves to be mounted on stacking type manifolds require suffix -K125M modification to provide necessary clearance for knob.

## CAM-OPERATED 4-WAY VALVES



**KSC-4212 Shown.**

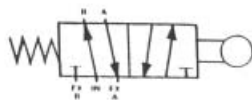

**KSC-4212:** (K 4.7) Cam-Operated—spring return, two-position

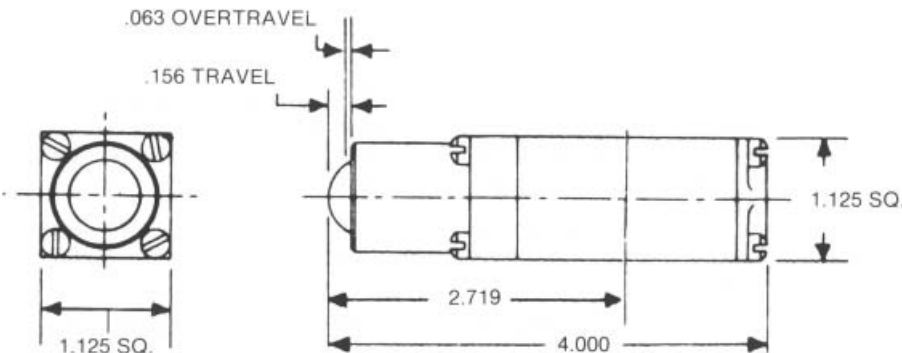



## COIL HOUSINGS

### Valve Suffix Detail



NEMA 1,2,3

**-none-** STANDARD CONDUIT HOUSING: Standard, threaded 1/2" NPT.



NEMA 1,2,3

**-KEP3** MS TYPE QUICK DISCONNECT: 3-prong MS type pin connector, fits 10SL-3S socket connector such as MS3106A-10SL-3S. Meets MIL-C-5015 specifications.

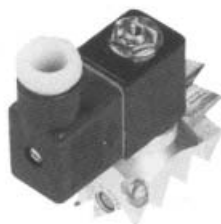

NEMA 4

**-HC** DIN-STANDARD TYPE COIL AND CONNECTOR WITH WIRE GRIP: 3-prong quick disconnect.

**-HCC** DIN-STANDARD TYPE COIL AND CONNECTOR WITH THREADS FOR 1/2" NPT CONDUIT: Otherwise same as -HC.

**-HCL** DIN-STANDARD TYPE COIL AND CONNECTOR WITH WIRE GRIP & INDICATOR LIGHT: Otherwise same as -HC.

**-HCCL** DIN-STANDARD TYPE COIL AND CONNECTOR WITH THREADS FOR 1/2" NPT CONDUIT & INDICATOR LIGHT: Otherwise same as -HC.



NEMA 1,2,3

**-243** GROMMET HOUSING: Leads protrude through grommeted hole.

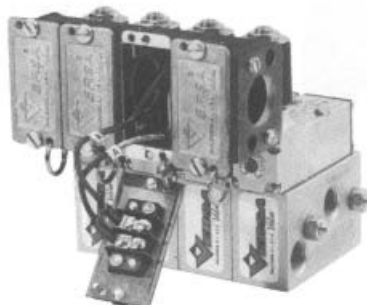

NEMA 12

**-JB** JUNCTION BOX: Has terminal strip on each cover—grounding screws inside. Can be applied whether valves are mounted on Stacking Manifold or Single Station Subplate. Fits all Series K4.7 and K6.5 solenoid valves except those with suffix -XX, -HC, -HCC, -HCL, -HCCL, -LB-XX, -027, and -043.

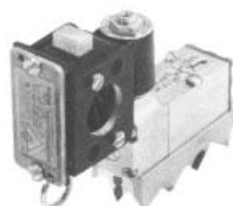

**-JB-K36B** JUNCTION BOX WITH INDICATOR LIGHT: Shows presence of coil signal. Otherwise same as -JB. Available only for voltages between AC: 80-125 volts, 50 or 60 Hz DC: 100-125 volts

### COMMON JUNCTION BOX

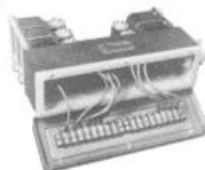

Item is ordered separately as **KCJB-1**, but is assembled to manifold.

If at least one double solenoid valve is included in the valve bank it can be mounted at one end in order to apply the Common Junction Box. All wiring for all of the solenoids in the valve bank can then be directed into the Common Junction Box, which includes a terminal strip on the cover. Maximum 10 stations.

## MANUAL OVERRIDE

### Valve Suffix Detail



**-KG** MANUAL OVERRIDE WITH GUARD: Probe operated. Available as option for remote pilot operated valves. Standard on all Series K4.7 and K6.5 solenoid operated valves. (No need to specify with suffix detail.)

**-KM** MANUAL OVERRIDE WITH PROTRUDING BUTTON: Available as option on all Series K4.7 and K6.5 solenoid or remote pilot operated valves.

**-KL** MANUAL OVERRIDE, PUSH-TURN HOLDING TYPE: (shown) Available as option on all Series K4.7 and K6.5 solenoid or remote pilot operated valves.



# SOLENOID OPERATORS FOR SPECIAL CONDITIONS

## Valve Suffix Detail

- 3 CONTINUOUS DUTY SOLENOID AND/OR HIGH AMBIENT OR MEDIA TEMPERATURE: Recommended when coil may be energized for long periods and/or when ambient or media temperature will exceed 120°F (50°C). Standard on valves with suffix option -LB-XX, -LB-XN, -XX and -XN. Not required on valves with suffix option -027 or -043.
- 027 DIN-LOW WATT (0.75 watts) SOLENOID OPERATOR FOR DC SERVICE: Suitable for PC interface. DIN style coil and connector. Maximum pressure for valve with this option is 115 psi. NEMA 4.
- 043 DIN-LOW WATT (2.9 watts) SOLENOID OPERATOR FOR AC OR DC SERVICE: Suitable for PC interface. DIN style coil and connector. Maximum pressure for valve with this option is 145 psi. NEMA 4.

## Valve Suffix Detail

- LB-XX OR -LB-XN (1.8 Watt) HAZARDOUS SERVICE LOW WATT SOLENOID OPERATOR—AIR ONLY: 1/2" NPT conduit housing. Maximum pressure for valve with this option is 120 psi. (Requires KX type stacking manifold.)  
-LB-XX: UL listed CSA certified for Class I—Groups C and D, Class II—Groups E, F, & G; NEMA 7 & 9.  
-LB-XN: ISSeP approved for zones 1 & 2 (IIB + H<sub>2</sub>), EEx d IIB + H<sub>2</sub> T6.
- XX HAZARDOUS SERVICE SOLENOID OPERATOR: UL listed or CSA certified for Class I—Groups C & D, Class II—Groups E, F, & G. NEMA 7 & 9. (Requires KX type Stacking Manifold.)
- XN HAZARDOUS SERVICE SOLENOID OPERATOR: ISSeP certified for Zones 1 and 2—EEx d IIB+H<sub>2</sub> T4 as per CENELEC standards EN 50014 and EN 50018. (Requires KX type stacking manifold.)
- XISP HAZARDOUS SERVICE SOLENOID OPERATOR, INTRINSICALLY SAFE: Factory Mutual and CSA certified for Division 1 and 2; Class I, II and III; Group A, B, C, D, E, F & G. PTB certified for Zone 1, 2 & 3—EEx ia IIC T6 per CENELEC standards EN 50 014 and EN 50 020. Requires the use of an approved safety barrier or isolator. 24VDC prior to barrier (1.6W max.).

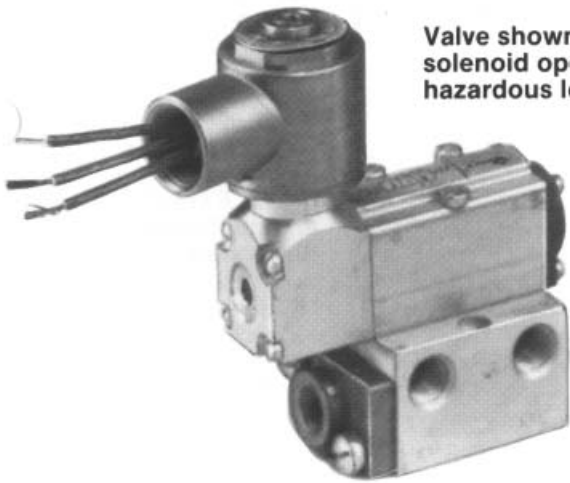

Valve shown with solenoid operator for hazardous locations.

NOTE: Several other hazardous service solenoid operators are available that meet various hazardous service specifications and international standards. Consult factory.

## VALVES FOR "OIL FREE SERVICE"

(not available for 5-way valves)

Double pilot operated-2 position and double solenoid operated-2 position Series K4.7 and K6.5 are suitable for "oil free service" without modification. Spring return-2 position valves that are pilot, solenoid, cam or manually actuated can be provided with the SELECTAIRE® option for "oil free service." See below:

### Valve Suffix Detail -6K

SELECTAIRE® Return combines spring force, constantly applied, with an air assisted pilot automatically applied on return only. Certain pressure restrictions apply. See Pressure Ranges on page 13. Also, before using SELECTAIRE® with a cylinder speed control note that valves with suffix -6K are limited to 300 cycles per minute.

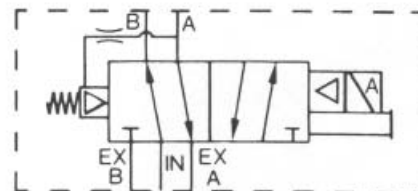

# Series K

## Subplates for Single Station Mounting

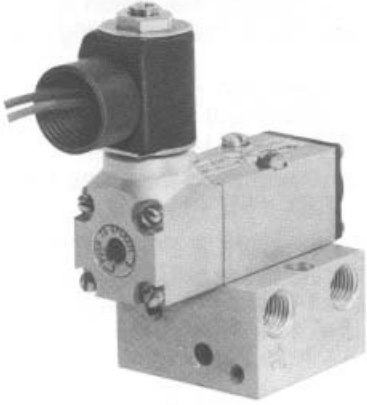

### 4-Way Valve Subplates

- KM-430** 1/4" NPT ports
- KM-440** 3/8" NPT ports
- KM-435** 1/4" NPT ports with individual bleed controls
- KM-445** 3/8" NPT ports with individual bleed controls

For all INPilot Solenoid, Manual, and Cam operated valves.

NOTE—When a combined threaded exhaust port is required, specify by adding "-E" to above part numbers.

- KM-430-K30** 1/4" NPT ports, except pilot ports are 1/8" NPT. Provides 2 separate exhaust ports. For bleed control use KM-BC Bleed Control Plate (page 12) or individual bleed control valves.

For all EXPilot Solenoid and all pilot operated valves. (Can be considered a universal subplate for all "K" series 4-way valves regardless of type or size.)

### 5-Way Valve Subplates

- KM-530** 1/4" NPT ports
- KM-540** 3/8" NPT ports

For all INPilot Solenoid, Manual, and Cam operated valves.

- KM-530-K30**

1/4" NPT ports, (except pilot ports are 1/8" NPT)

For all EXPilot Solenoid and pilot operated valves. (Can be considered a universal subplate for all "K" series 5-way valves regardless of type or size.)

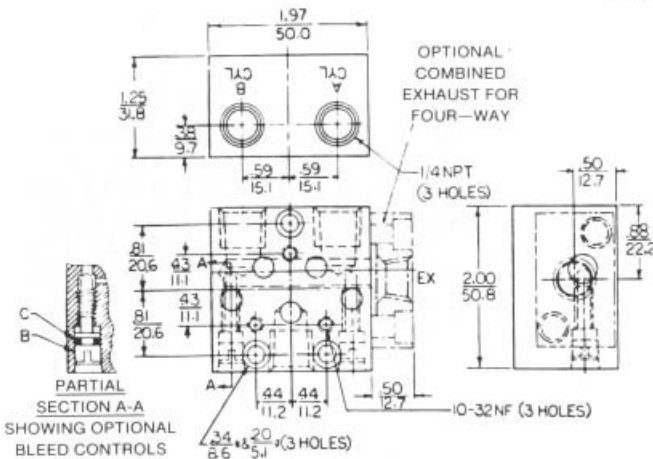

Typical Four-Way (KM-435) and Five-Way (KM-530) Subplate Dimensions

## CYLINDER MOUNT SUBPLATES

Cylinder mount subplate allows Series K valve to mount directly on cylinder of any length.

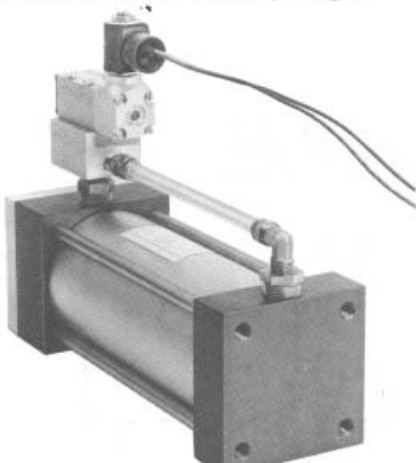

- CMKM-430** without speed controls
- CMKM-435** with speed controls

Inlet and end cylinder port 1/4" NPT  
Bottom cylinder port 3/8" NPT

- CMKM-440** without speed controls
- CMKM-445** with speed controls

All ports 3/8" NPT

NOTE—When a combined threaded exhaust port is required, specify by adding "-E" to above part numbers.

## STACKING MANIFOLDS

Almost any combination of valves may be grouped on Stacking Manifolds joined to provide a single manifold assembly. The basic Series K Stacking Manifolds are listed below. The different types can be interspersed in a single manifold assembly. In the part numbers, change the asterisk to the number of stations required. (see How to Order, page 15.) Series K valves and manifold assemblies will be shipped factory-assembled and tested at no extra charge.

Among manifolds not listed below are "Top Supply Modules" and "Bottom Supply Modules." These provide an additional inlet and exhaust port on either the top or bottom surface of the stack. INPilot and EXPilot versions are available.

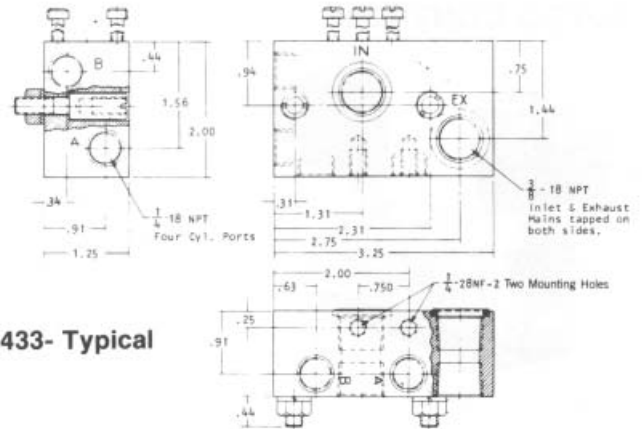

**KM-433- Typical**

**For KD or KX manifold thickness dimension is 1.50".**

VALVE FUNCTION without pressure regulation (Supply main is connected to valve inlet)	VALVE TYPE USED	STACKING MANIFOLD	
		For use with any valve type listed (except those equipped with solenoid for hazardous locations) and WITHOUT regulator function.	For use with valves equipped with solenoid for hazardous locations, and WITHOUT regulator function.
<b>4-Way</b>	4-Way, INPilot/solenoid . . . 4-Way, Manual or Cam . . . . 4-Way, EXPilot/solenoid . . . 4-Way, Remote Pilot . . . . .	KM-433-* . . . . . KM-433-* . . . . . KM-433-* -KG30 . . . . . KM-433-* -KP30 . . . . .	KX-433-* . . . . . KX-433-* -KG30 . . . . .
<b>3-Way NC</b>	4-Way, INPilot/solenoid . . . 4-Way, Manual or Cam . . . . 4-Way, EXPilot/solenoid . . . 4-Way, Remote Pilot . . . . .	KM-4331-* . . . . . KM-4331-* . . . . . KM-4331-* -KG30 . . . . . KM-4331-* -KP30 . . . . .	KX-4331-* . . . . . KX-4331-* -KG30 . . . . .
<b>3-Way NO</b>	4-Way, INPilot/solenoid . . . 4-Way, Manual or Cam . . . . 4-Way, EXPilot/solenoid . . . 4-Way, Remote Pilot . . . . .	KM-4332-* . . . . . KM-4332-* . . . . . KM-4332-* -KG30 . . . . . KM-4332-* -KP30 . . . . .	KX-4332-* . . . . . KX-4332-* -KG30 . . . . .
<b>2-Way NC</b>	4-Way, INPilot/solenoid . . . 4-Way, Manual or Cam . . . . 4-Way, EXPilot/solenoid . . . 4-Way, Remote Pilot . . . . .	KM-4333-* . . . . . KM-4333-* . . . . . KM-4333-* -KG30 . . . . . KM-4333-* -KP30 . . . . .	KX-4333-* . . . . . KX-4333-* -KG30 . . . . .
<b>2-Way NO</b>	4-Way, INPilot/Solenoid . . . 4-Way, Manual or Cam . . . . 4-Way, EXPilot/solenoid . . . 4-Way, Remote Pilot . . . . .	KM-4334-* . . . . . KM-4334-* . . . . . KM-4334-* -KG30 . . . . . KM-4334-* -KP30 . . . . .	KX-4334-* . . . . . KX-4334-* -KG30 . . . . .
<b>Diverter, or Selector</b>	Diverter and Selector valves are available. Consult factory.	Diverter, and Selector Type Stacking Manifolds are available. Consult factory for details.	

VALVE FUNCTION with pressure regulation	VALVE TYPE USED	STACKING MANIFOLD	
		For use with valve type listed and WITH individual Sandwich Regulator Plate.	For use with any valve type listed and WITH Integral Pressure Regulation [Auxiliary main(s) connected to valve inlet(s)].
<b>4-Way</b>	4-Way, INPilot/solenoid . . . 4-Way, Manual or Cam . . . . 4-Way, EXPilot/solenoid . . . 4-Way, Remote Pilot . . . . .	KM-433-* . . . . . PLUS appropriate Sandwich Regulator Plate for each valve KM-433-* . . . . . KM-433-* -KG30 . . . . . KM-433-* -KP30 . . . . .	KD-433-* . . . . . PLUS appropriate Integral Pressure Regulator Manifold for each group of valves KD-433-* . . . . . KD-433-* -KG30 . . . . . KD-433-* -KP30 . . . . .
<b>3-Way NC</b>	4-Way, INPilot/solenoid . . . 4-Way, Manual or Cam . . . . 4-Way, EXPilot/solenoid . . . 4-Way, Remote Pilot . . . . .	KM-4331-* . . . . . PLUS appropriate Sandwich Regulator Plate for each valve KM-4331-* . . . . . KM-4331-* -KG30 . . . . .	KD-4331-* . . . . . PLUS appropriate Integral Pressure Regulator Manifold for each group of valves KD-4331-* . . . . . KD-4331-* -KG30 . . . . . KD-4331-* -KP30 . . . . .
<b>3-Way NO</b>	4-Way, INPilot/solenoid . . . 4-Way, Manual or Cam . . . . 4-Way, EXPilot/solenoid . . . 4-Way, Remote Pilot . . . . .	KM-4332-* . . . . . PLUS appropriate Sandwich Regulator Plate for each valve KM-4332-* . . . . . KM-4332-* -KG30 . . . . .	KD-4332-* . . . . . PLUS appropriate Integral Pressure Regulator Manifold for each group of valves KD-4332-* . . . . . KD-4332-* -KG30 . . . . . KD-4332-* -KP30 . . . . .
<b>2-Way NC</b>	4-Way, INPilot/solenoid . . . 4-Way, Manual or Cam . . . . 4-Way, EXPilot/solenoid . . . 4-Way, Remote Pilot . . . . .	KM-4333-* . . . . . PLUS appropriate Sandwich Regulator Plate for each valve KM-4333-* . . . . . KM-4333-* -KG30 . . . . .	KD-4333-* . . . . . PLUS appropriate Integral Pressure Regulator Manifold for each group of valves KD-4333-* . . . . . KD-4333-* -KG30 . . . . . KD-4333-* -KP30 . . . . .
<b>2-Way NO</b>	4-Way, INPilot/Solenoid . . . 4-Way, Manual or Cam . . . . 4-Way, EXPilot/solenoid . . . 4-Way, Remote Pilot . . . . .	KM-4334-* . . . . . PLUS appropriate Sandwich Regulator Plate for each valve KM-4334-* . . . . . KM-4334-* -KG30 . . . . .	KD-4334-* . . . . . PLUS appropriate Integral Pressure Regulator Manifold for each group of valves KD-4334-* . . . . . KD-4334-* -KG30 . . . . . KD-4334-* -KP30 . . . . .
<b>5-Way</b>	5-Way, Manual or Cam . . . . . 5-Way, EXPilot/solenoid . . . 5-Way, Remote Pilot . . . . .	. . . . . . . . . . . . . . .	KD-533-* . . . . . PLUS appropriate Integral Pressure Regulator Manifold for each group of valves KD-533-* -KG30 . . . . . KD-533-* -KP30 . . . . .
<b>Diverter, or Selector</b>	Diverter and Selector valves are available. Consult factory.	Diverter, and Selector Type Stacking Manifolds are available. Consult factory for details.	

# Series K

## SPEED CONTROLS

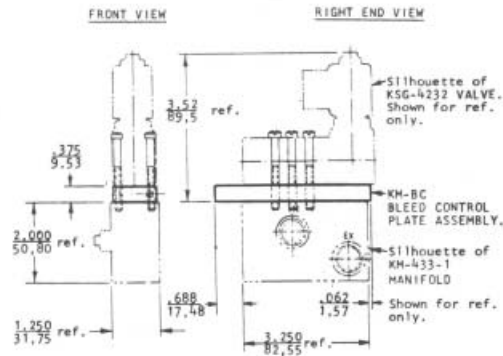
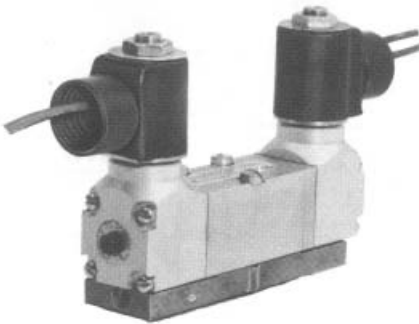

TWO VIEWS SHOWING LOCATION OF KM-BC ON PAKDAIR MANIFOLD ASSEMBLY.

**KM-BC CYLINDER BLEED CONTROL PLATE:** Mounts between valve and Stacking Manifold; 9.5mm (3/8 in.) thick. KM-BC has 6.5mm (1/4 in.) diameter flow passages. For either K 6.5 or K 4.7 valves. (Not for use with 5-Way valves)

## REGULATORS

SERIES K "Regulator Modules" stack right in with the valves. Matching manifold modules fit standard K 4.7 or K 6.5 EXPilot Series K valves. Auxiliary Main supplies regulated pressure to the valve inlet. The Supply Main carries unregulated pressure to other downstream valves and/or regulators. Schematic shows 4-way; 3-way and 5-way also available.

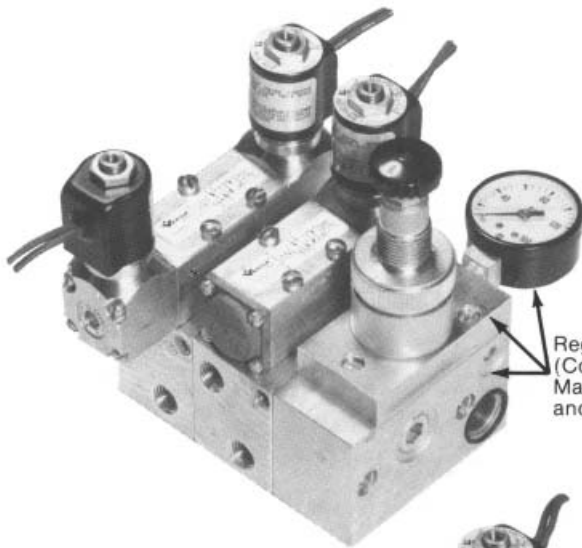

Regulator Module (Consists of Regulator Manifold, Regulator and Gauge Assembly)

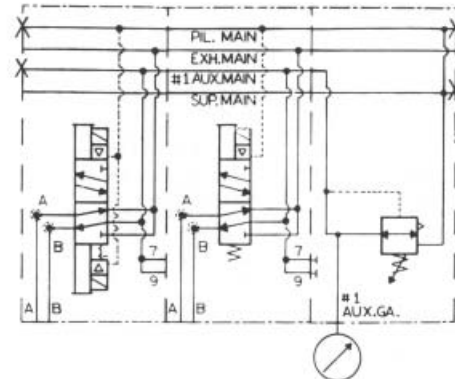

For controlling air pressure to just one valve, a "Sandwich Regulator" is available. It fits between valve and stacking manifold module.

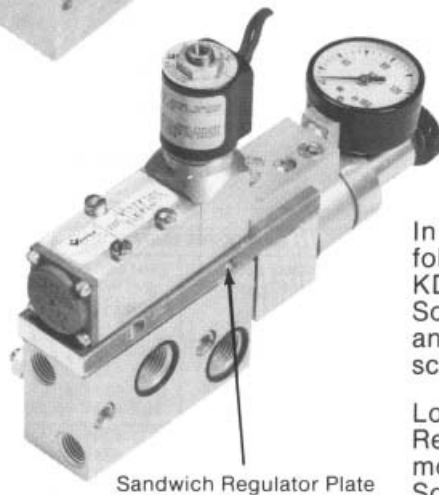

Sandwich Regulator Plate

In upper left photo, a KD-433-1-KG30-XGO-X1AO Manifold with KGG-4232-K30 Double-Solenoid Valve and KD-433-1-KG30 Manifold with KSG-4212-K30 Single-Solenoid Valve are fed by a KAR-190-125G Regulator and Gauge on a KR-430-KF30-XG3-XS3 Manifold. See schematic.

Lower photo shows a KAR-19VS-KF30-125G Sandwich Regulator with KR-19V-GA adapter plate for side mounting Gauge between a KSG-4212-K30 Single-Solenoid Valve and a KM-433-1 Manifold.

## MOUNTING BRACKETS

Mounting bracket sets are not required for mounting of the Stacked Manifold assembly, but can be supplied when desired. See "How to Order," page 15.

**-SB10 MOUNTING BRACKET SET:** Has supply and exhaust port plate at one end (left view), blank panel at other (right view).

**-SS10 MOUNTING BRACKET SET:** Has supply and exhaust port plate at both ends.

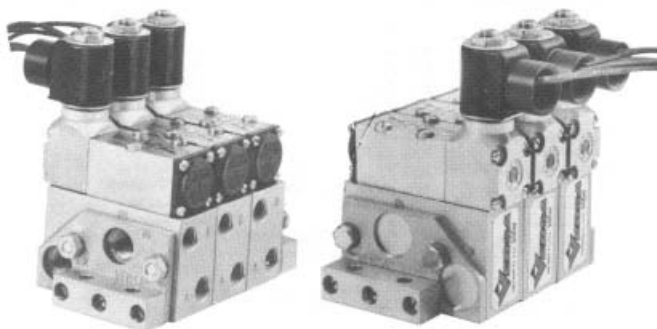

## SPECIFICATIONS

### SERIES K4.7 or SERIES K6.5 PRESSURE RANGES

INTERNAL PILOTING (INPilot) SOLENOID VALVES			
Service	Size	Main Valve Pressure*	Piloting Pressure
All Double Actuated Valves	K 4.7	25-175 psi (1.7-12.0 bar)†	Uses Inlet Pressure for Piloting. No Auxiliary Pressure or Separate Piping Required.
	K 6.5		
Single Actuated Valves for Oil-Free Service, using -6K Selectaire Return	K 4.7	55-175 psi (3.8-12.0 bar)†	
	K 6.5	45-175 psi (3.1-12.0 bar)†	
Single Actuated Valves for Lubricated Service, using Standard Spring Return	K 4.7	40-175 psi (2.8-12.0 bar)†	
	K 6.5	30-175 psi (2.1-12.0 bar)†	

EXTERNAL PILOTING (EXPilot) SOLENOID, PILOT, CAM, MANUAL VALVES			
Service	Size	Main Valve Pressure	Piloting Pressure*
All Double Actuated Valves	K 4.7	Vacuum to 175 psi (12.0 bar)	25-175 psi (1.7-12.0 bar)†
	K 6.5		
Single Actuated Valves for Oil-Free Service, using -6K Selectaire Return	K 4.7	25-175 psi** (1.7-12.0 bar)	55-175 psi** (3.8-12.0 bar)†
	K 6.5	5-175 psi** (0.4-12.0 bar)	45-175 psi** (3.1-12.0 bar)†
Single Actuated Valves for Lubricated Service, using Standard Spring Return	K 4.7	Vacuum to 175 psi (12.0 bar)	40-175 psi (2.8-12.0 bar)†
	K 6.5		30-175 psi (2.1-12.0 bar)†

\*Maximum pressure for valves with -LB-XX or -LB-XN is 120 psi (8.3 bar). Maximum pressure for valves with -027 is 115 psi (8.0 bar), or with -043 is 145 psi (10.0 bar).

\*\*Main valve pressure must be equal to or less than pilot pressure. Oil-Free Service valves (suffix-6K) are limited to 300 cycles per minute.

$$\dagger \text{MPa} = \frac{\text{bar}}{10}$$

### Cylinder Extension Speed Using Series K4.7 or K6.5

A double-acting cylinder of up to this bore (in.):

	Valve	1½	1¾	2	3¼	4	6
Will extend at a speed of at least (in. per sec.):	K 4.7	36	24	12	6	3	1
	K 6.5	48	36	24	12	6	3

This table is meant as a valve selection guide only. It was constructed as a result of extensive valve-performance testing with a wide variety of cylinders using short lines, 4.1-6.2 bar (60-90 psi) at the valve, cycle rates of 60 cpm or less, small difference in effective area, equal inlet and exhaust Cv factors, and loads requiring less than 2.1 bar (30 psi) to initiate movement.

**Minimum Flow Diameter:** Valves — K4.7 = 3/16" Ø area, Cv=0.7 (42 SCFM @ 100 psi) Manifolds & Subplates—  
K6.5 = 1/4" Ø area, Cv=1.2 (72 SCFM @ 100 psi) 1/4" Ø area

**Construction:** aluminum & stainless steel

**Seals:** Flow area seals — FKM (fluorocarbon) Static seals — NBR (Nitrile)

**Temperature Range:** 0°F (-18°C) to 200°F (95°C) including medium/ambient temperature. The table below lists suggested suffix options for various temperature ranges and/or types of service. Select those options for the maximum temperature or type of service anticipated. Maximum temperature and available options may vary with type of solenoid coil. See Pages 9 and 14.

Temperature Range (Medium/Ambient Temperature)	Type of Service					
	Intermittent Duty Service			Continuous Duty (Deadend) Service		
	AC or DC		AC		DC	
	Coil	Solenoid Plunger	Coil	Solenoid Plunger	Coil	Solenoid Plunger
150°F (65°C) to 200°F (95°C)	Suffix -HT	Suffix -3 (included in suffix -HT, -XN, -XX, -LB-XX)	Suffix -HT	Suffix -3 (included in suffix -HT, -XN, -XX, -LB-XX)	Suffix -HT	Suffix -3 (included in suffix -HT, -XN, -XX, -LB-XX)
120°F (50°C) to 150°F (65°C)	—	Suffix -3 (included in suffix -XX, -XN, -LB-XX)	—	Suffix -3 (included in suffix -XX, -XN, -LB-XX)	Suffix -HT	Suffix -3 (included in suffix -HT, -XN, -XX, -LB-XX)
0°F (-18°C) to 120°F (50°C)	—	—	—	Suffix -3 (not required for suffix -XX, -XN, -LB-XX)	—	Suffix -3 (not required for suffix -XX, -XN, -LB-XX)

**Filtration & Lubrication:** Versa Series K4.7 & K6.5 valves are lubricated during assembly to insure that they will operate to specifications when installed in the system. To maintain reliability and normal life, it is important to filter and lubricate the air that is passing through the valves.

35-50 micron filtration is recommended.

For a complete list of suitable lubricating oils, request Product Bulletin 113R2. Where continued lubrication is not possible, see page 9 ("Oil Free Service" Valves).



# Series K

## Electrical Specifications

### Solenoid Operator Information

Electrical Specifications		Nominal Coil Power		Coil Voltage																
		AC	DC	AC					DC											
				Voltage	Coil Code	Inrush Amps	Holding Amps	Ohms	Voltage	Coil Code	Inrush & Holding Amps	Ohms								
Nonhazardous—Standard (NEMA 1,2,3)	All coils are Class A epoxy molded.* Rated voltage continuous duty 100%.	6W	7W	24/50	<b>E024</b>	0.61	0.37	25	6	<b>D006</b>	1.3	5								
				110/50	<b>E110</b>	0.13	0.08	475	12	<b>D012</b>	0.63	19								
Hazardous Service—Standard [Requires KX type Stacking Manifold] (-XX: UL listed or CSA certified for Class I—Groups C & D, Class II—Groups E, F, & G, NEMA 7 & 9) (-XN: ISSeP certified for Zones 1 & 2—EEx d IIB + H, T4 per Cenelec 50 018 & 50 020)	Standard Wattage Suffix -XX or -XN	5.6W	7.2W	220/50	<b>E220</b>	0.07	0.04	2030	24	<b>D024</b>	0.32	75								
				230/50	<b>E230</b>	0.06	0.04	2532	47	<b>D047</b>	0.16	295								
				240/50	<b>E240</b>	0.06	0.04	2714	125	<b>D125</b>	0.06	2030								
				24/60	<b>A024</b>	0.63	0.38	19												
				120/60	<b>A120</b>	0.13	0.08	475												
				240/60	<b>A240</b>	0.06	0.04	2000												
				480/60(-xx)	<b>A480</b>	0.03	0.02	8460												
				24/60	<b>A024</b>	0.29	0.15	43	6	<b>D006</b>	0.32	19								
				120/60	<b>A120</b>	0.06	0.03	1085	12	<b>D012</b>	0.16	75								
				240/60	<b>A240</b>	0.03	0.02	5050	24	<b>D024</b>	0.08	312								
Hazardous Service—Low Watt [Requires KX type Stacking Manifold] (-LB-XX: UL listed or CSA certified for Class I—Groups C & D, Class II—Groups E, F, & G, NEMA 7 & 9) (-LB-XN: ISSeP certified for Zones 1 & 2—EEx d IIB + H, T4 per Cenelec 50 018 & 50 020)	Low Wattage Suffix -LB-XX or -LB-XN	1.8W	1.8W	48	<b>D048</b>	0.04	0.04	1337	48	<b>D120</b>	0.02	7815								
				120																
				6	<b>D006</b>	0.125	47													
				12	<b>D012</b>	0.063	193													
				24	<b>D024</b>	0.031	724													
				48	<b>D048</b>	0.017	2310													
				Nonhazardous Service DIN-Low Watt (NEMA 4)	All coils are Class F epoxy molded. Rated voltage continuous duty 100%.	Suffix -027	0.75W	—	—	—	—	—	—	—	—	—				
								Suffix -043	4.0VA @ 50Hz	2.9W	24/50	<b>E024</b>	0.21	0.16	78					
											110/50	<b>E110</b>	0.045	0.035	1715					
											220/50	<b>E220</b>	0.023	0.017	7750					
12	<b>D012</b>	0.24	47																	
24	<b>D024</b>	0.12	193																	
48	<b>D048</b>	0.06	724																	
Nonhazardous Service DIN-Standard (NEMA 4)	All coils are Class A epoxy molded. Rated voltage continuous duty 100%.	Suffix -HC -HCC -HCCL -HCL	8.5W								10.5W	24/60-	<b>A024</b>	0.63	0.50	26				
												110/50	<b>E110</b>	0.13	0.10	647				
												120/60	<b>A120</b>	0.13	0.10	647	12	<b>D012</b>	0.87	14
				240/50	<b>E240</b>	0.06	0.04					2714	24	<b>D024</b>	0.43	55				
				220/50-	<b>E220</b>	0.06	0.05	2790	48	<b>D048</b>		0.22	222							
				240/60	<b>A240</b>	0.06	0.05	2790												

\*Also available are Class H molded coils. Specify with suffix -HT

\*Any coil can be potted within the coil housing: Suffix -PC: for Nonhazardous or Hazardous Service

Versa exercises diligence to assure that information contained in this catalog is correct, but does not accept responsibility for any errors or omissions. Versa also reserves the right to change or delete data or products at any time without prior notification. To be sure the data you require is correct, consult factory.



## HOW TO ORDER

- A) Select valve product numbers from pages 4 thru 7. Apply required valve options from pages 8 and 9. For solenoid valves, also indicate voltage/Hz requirements by using coil code on page 14.
- B) Select product number for stacking manifold from page 11 (replacing asterisk with number of like stations required), or select single station subplate from page 10.
- C) List each valve station separately starting at the left end of the manifold assembly (when facing the side cylinder ports with valves on top of manifold assembly), unless all stations are identical. In that case the manifold assembly may be listed on one line and identical valves listed on line 2. If valves are not identical, start with any double solenoids, then single solenoids, then pilot valves, listing each group of identical valves on a separate line. Accessory items such as Bleed Control Plates should be listed after each valve or group of valves to which they are to be applied.
- D) Factory completely assembles and tests valves and manifold assembly at no charge.

## Bills of Material

4 Valve Manifold With Manifold Stations Identical  
 \*\*\*\*S.O.M.  
 1 KM-433-4-SB10  
 4 KSG-4332  
 \*\*\*\*E.O.M.

4 Valve Manifold with Manifold Stations Identical and With One Cylinder Speed Control Plate  
 \*\*\*\*S.O.M.  
 1 KM-433-4-SB10  
 1 KGG-4232-JB  
 1 KM-BC  
 3 KSG-4332-JB  
 \*\*\*\*E.O.M.

4 Valve Manifold With 3-Way Valve And Speed Controls  
 \*\*\*\*S.O.M.  
 1 KM-433-3-SB10  
 1 KM-4331-1  
 1 KGG-4232-243  
 1 KM-BC  
 1 KGG-4232-243  
 1 KXX-4333-243  
 1 KSG-4332-243  
 \*\*\*\*E.O.M.

## REPAIR KITS

	Body Kit only	Solenoid + Body Kit	
		Single Solenoid	Double Solenoid
K4.7 valve	K-4232	K-4232-GAC K-4232-GDC	K-4232-GGAC K-4232-GGDC
K6.5 valve	K-4332	K-4332-GAC K-4332-GDC	K-4332-GGAC K-4332-GGDC
Regulators	KRK-090		

Notes: 1. Body Kits include all seals for the rebuilding of valve body and pilot, or regulator.

2. Solenoid + Body Kits include all seals for the rebuilding of valve body, pilot, and solenoid operator sleeve, plunger and spring.

## 3-Way and 5-Way (Dual-Pressure 4-way) Valves

2 and 3-Way valve functions are accomplished by using a 4-way valve on the appropriate Stacking Manifold in which the appropriate port(s) has been plugged, or on a single station 4-Way Subplate.

5-Way valves are only available in K6.5 size. Any K6.5 valve listed can be supplied as a 5-Way. To specify change first digit of the product number to "5." Example: KSG-4332 becomes KSG-5332.

To order regulated-pressure products, or master shut off stations, consult factory.



# IF YOU HAVEN'T FOUND THE VALVE YOU NEED, YOU HAVEN'T ASKED US.

Versa Valves... designed, built, and tested  
to meet your air requirements.

## **SERIES "B" VALVES:**

1/8" NPT, 3/16" (4.7mm) Orifice. Two- & Three-Way. Brass & SS Construction. Manual, Pilot & Cam Actuation. Pneumatic Service Vacuum to 200 psi (14 bar). Bulletin B.

## **SERIES "B-316", "B-900" & "B-550" VALVES FOR PANEL BUILDERS:**

Suitable for Offshore, Process Control, Material Specs Meet NACE MR-01-75. Fluorocarbon Seals, 1/4" NPT, 3/16" (5mm) Orifice. Three-Way. Solenoid/Pilot, Remote Pilot, Mechanical, Manual & Many Special Actuators. Main Supply Reset Valves; First Out Indicating Valves. Pneumatic Service Vacuum to 200 psi (14 bar). Bulletin B316.

## **SERIES "C" VALVES:**

10-32 (M5), 1/8" NPT or G1/8", 1/4" NPT or G1/4, 0.6 to 7mm Orifice. Three- & Four-Way, Multi-purpose. Individual Mount, Stacking, or Manifold Mounted. Aluminum, SS & Nylon Construction. Solenoid/Pilot, Pilot, Manual & Mechanical Actuation. Pneumatic Service Vacuum to 115 psi (8 bar). Bulletin C.

## **SERIES "E" VALVES:**

1/8" NPT & 1/4" NPT. 1/32" (0.8mm) thru 1/4" (6.4mm) Orifice. Two- & Three-Way, Directional, Multi-Purpose. Sideported, and Manifold Mounted. SS or Aluminum Construction. Direct Solenoid Actuation, including **LOW WATT**. Pneumatic & Hydraulic Service Vacuum to 500 psi (35 bar). Bulletin E.

## **SERIES "K" VALVES:**

Compact Air Management System. 1/4" NPT or G1/4", 4.7mm & 6.5mm Orifice. Two-, Three-, Four- & Five-Way, Selector, Diverter. Manifold Mounted, Integrated Circuitry, Aluminum Construction. Fluorocarbon Seals. Solenoid/Pilot, Remote Pilot, Cam & Manual Actuation. Pneumatic Service Vacuum to 175 psi (12 bar). Bulletin K.



## **SERIES "L-MINI" VALVES:**

1/8" NPT Standard, 9/64" (3.6mm) Orifice, Two- & Three-Way. Replace Electrical Limit Switches. Hand, Cam & Panel Actuators. Aluminum & SS Construction. Pneumatic Service Vacuum to 200 psi (14 bar). Bulletin L-Mini.

## **SERIES "V" & "T" VALVES:**

1/8" thru 1-1/4" NPT or G, Full Ported. Two-, Three-, Four- & Five-Way, Selector, Diverter. All types of Actuation. Forged Brass Construction. Pneumatic Service Vacuum to 200 psi (14 bar), Hydraulic Service to 500 psi (35 bar). Bulletin VT.

## **SERIES "V-316" STAINLESS STEEL VALVES:**

Suitable for Offshore, Process Control. Material Specs Meet NACE MR-01-75. Fluorocarbon Seals. 1/4", 3/8", 1/2" NPT, Full Ported. Two-, Three-, Four- & Five-Way. Selector. Diverter. All Types of Actuation. Pneumatic Service Vacuum to 200 psi (14 bar). Bulletin V316.

## **SOLENOID VALVES FOR THE PROCESS CONTROL INDUSTRY:**

Complete Range of Stainless Steel, Brass or Aluminum Constructed Valves, 1/8" NPT through 1 NPT. Direct NAMUR Mount & Bodyported Styles. Latching Manual Reset, Lockout Valves, Redundant Valves. Bulletin PCg.

## **ACCESSORIES:**

Shuttle Valves, Bleed Control Valves, Dust Excluders, Foot Guards, Bleed Valves, Quick Exhaust Valves, Status Indicators. Bulletin ACC.

## **WARNINGS REGARDING THE DESIGN APPLICATION, INSTALLATION AND SERVICE OF VERSA PRODUCTS**

The warnings below must be read and reviewed before designing a system utilizing, installing, servicing, or removing a Versa product. Improper use, installation or servicing of a Versa product could create a hazard to personnel and property.

### **DESIGN APPLICATION WARNINGS**

Versa products are intended for use where compressed air or industrial hydraulic fluids are present. For use with media other than specified or for non-industrial applications or other applications not within published specifications, consult Versa.

Versa products are not inherently dangerous. They are only a component of a larger system. The system in which a Versa product is used must include adequate safeguards to prevent injury or damage in the event of system or product failure, whether this failure be of switches, regulators, cylinders, valves or any other system component. System designers must provide adequate warnings for each system in which a Versa product is utilized. These warnings, including those set forth herein, should be provided by the designer to those who will come in contact with the system.

Where questions exist regarding the applicability of a Versa product to a given use, inquiries should be addressed directly to the manufacturer. Confirmation should be obtained directly from the manufacturer regarding any questioned application prior to proceeding.

### **INSTALLATION, OPERATION AND SERVICE WARNINGS**

Do not install or service any Versa product on a system or machine without first depressurizing the system and turning off any air, fluid, or electricity to the system or machine. All applicable electrical,

mechanical, and safety codes, as well as applicable governmental regulations and laws must be complied with when installing or servicing a Versa product.

Versa products should only be installed or serviced by qualified, knowledgeable personnel who understand how these specific products are to be installed and operated. The individual must be familiar with the particular specifications, including specifications for temperature, pressure, lubrication, environment and filtration for the Versa product which is being installed or serviced. Specifications may be obtained upon request directly from Versa. If damages should occur to a Versa product, do not operate the system containing the Versa product. Consult Versa for technical information.

### **LIMITED WARRANTY DISCLAIMER AND LIMITATION OF REMEDIES**

Products sold by Versa are warranted to be free from defective material and workmanship for a period of ten years from the date of manufacture, provided said items are used in accordance with Versa specifications. Versa's liability pursuant to that warranty is limited to the replacement of the Versa product proved to be defective provided the allegedly defective product is returned to Versa or its authorized distributor.

Versa provides no other warranties, expressed or implied, except as stated above. There are no implied warranties of merchantability or fitness for a particular purpose. Versa's liability for breach of warranty as herein stated is the only and exclusive remedy and in no event shall Versa be responsible or liable for incidental or consequential damages.

Versa Products Company, Inc., 22 Spring Valley Road, Paramus, New Jersey, USA 07652 • 201/843-2400 FAX: 201/843-2931 e-mail: sales@versa-valves.com  
Versa BV, Prins Willem Alexanderlaan 1429, 7321 GB Apeldoorn, The Netherlands • +31-55-3681900 FAX: +31-55-3681909 e-mail: sales@versa-valves.com

**VERSA**<sup>®</sup>  
Valves  
www.versa-valves.com